

AQUAMIST Mist Control Center (MCC) Pump Skid Unit

General Description

The TYCO AQUAMIST Mist Control Center (MCC) Pump Skid Unit is a pre-assembled, self-contained, control center for Ultra Low Flow AQUAMIST Systems. The compact skid unit, which has been pre-wired and pre-piped, is designed for ease of installation and to reduce time and labor required for field installation. The MCC is factory assembled and functionally tested, ready to connect to the system and an adequate water supply.

This unit consists of a positive displacement pump coupled to an electric motor which is factory wired to a full service motor controller. The pump discharge is connected to a pressure regulating loop which redirects unused water to the pump inlet, to a thermal relieving device which provides cooling to the recirculated fluid, and to a pressure relieving loop which will direct water to the pump inlet in the event of a blockage of flow.

The MCC is available in six sizes. The MCC-1 and MCC-A are capable of providing a maximum flow rate of 50 gpm (189 lpm); the MCC-2 and MCC-B are capable of providing a maximum flow rate of 100 gpm (378 lpm); the MCC-3 and MCC-C are capable of providing a maximum flow rate of 150 gpm (568 lpm).

The MCC is also available with two output pressure settings. The MCC-1, MCC-2 and MCC-3 are set to output a maximum of 250 psi (17,2 bar). The MCC-A, MCC-B and MCC-C are set to output 175 psi (12,1 bar).



Technical Data

Approvals

The TYCO AQUAMIST Mist Control Center (MCC) Pump Skid Unit is FM Approved as a component of FM Approved TYCO AQUAMIST systems when configured as the wet pipe, deluge, and single interlock preaction system arrangements. Refer to Table A for FM Approved applications and the technical data sheets describing them.

The MCC Pump Skid Unit can also be configured as a double interlock preaction system arrangement that can be used for a performance based design or other applications not FM Approved.

All cabinets, skids, and enclosures which incorporate Approved components, as well as commercial-off-the-shelf industry accepted components, meet the requirements of NFPA 750 and NFPA 20.

Maximum Pressures

MCC-1, 2 and 3:

- System Pressure250 psi (17,2 bar)
- Working Pressure. 240 psi (16,5 bar)

MCC-A, B and C:

- System Pressure175 psi (12,1 bar)
- Working Pressure. 170 psi (11,7 bar)

Minimum Inlet Supply Pressure

All MCC Models0 psi

Minimum Inlet Supply Capacity

Match system design calculations

FM Approved Application	TFPP Technical Data Sheet
HC-1	TFP2230
Data Processing Equipment Rooms/Halls	TFP2233
Machinery Spaces & Combustion Turbine Enclosures	TFP2234
Industrial Fryer Protection (IFP)	TFP2240

**TABLE A
AQUAMIST MCC
MIST CONTROL CENTER
PUMP SKID UNIT
FM APPROVED APPLICATIONS**

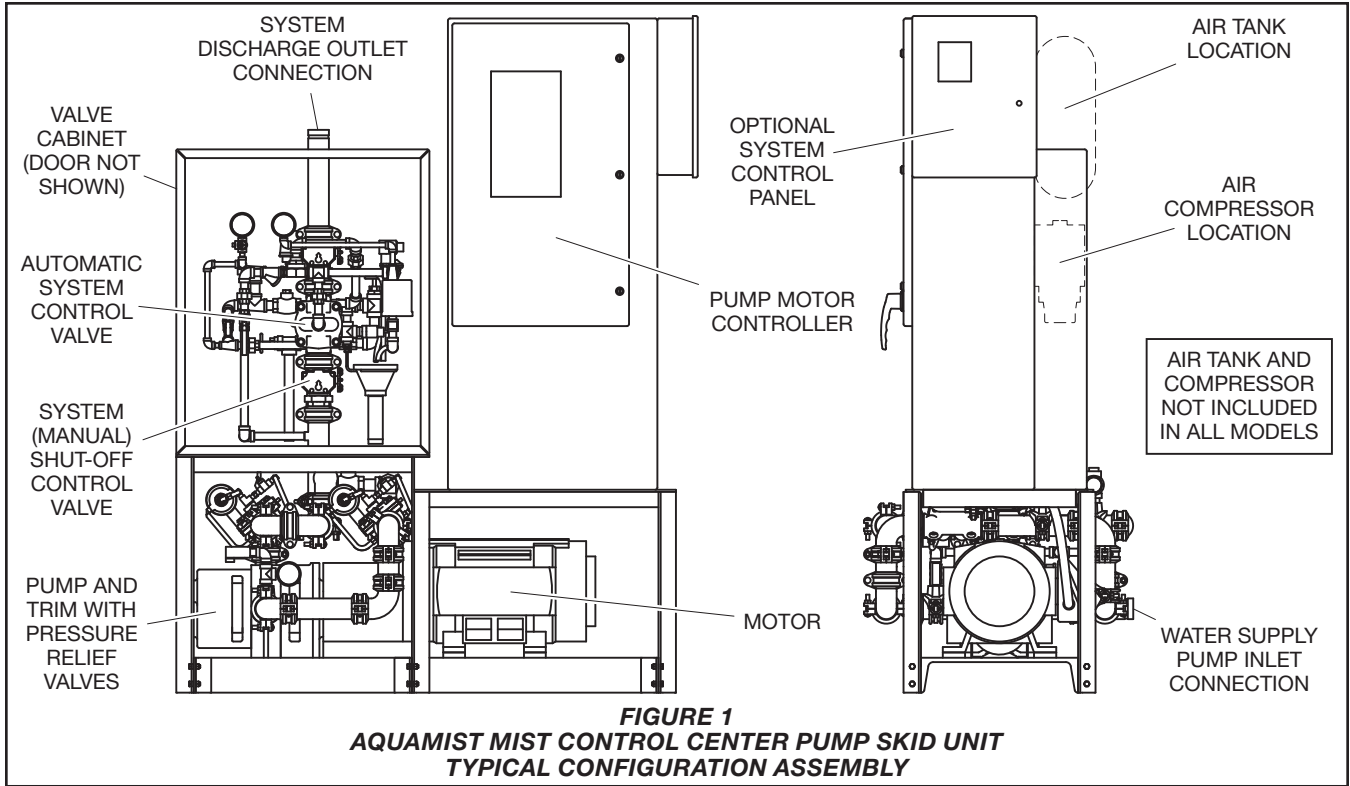

Discharge Connection Working Pressure psi (bar)	Capacity gpm (lpm)	Frequency (Hz)	Pump Model	MCC Model	Motor Power hp (kw)	Pump Inlet Connection Nominal Grooved Pipe Size Inch (DN)
240 (16,5)	57 (216)	50	160-332 HD	MCC-1	25 (19)	2 (50)
	56 (212)	60	80-440 HD		20 (15)	2 (50)
	110 (416)	50	300-372 HD	MCC-2	40 (30)	3 (80)
	106 (401)	60	160-338 HD		40 (30)	2 (50)
	166 (628)	50	300-368 HD	MCC-3	60 (45)	3 (80)
	165 (624)	60	330-388 HD		50 (37)	3 (80)
170 (11,7)	57 (216)	50	160-332 HD	MCC-A	25 (19)	2 (50)
	56 (212)	60	80-440 HD		20 (15)	2 (50)
	110 (416)	50	300-372 HD	MCC-B	40 (30)	3 (80)
	106 (401)	60	160-338 HD		40 (30)	2 (50)
	166 (628)	50	300-368 HD	MCC-C	60 (45)	3 (80)
	165 (624)	60	330-388 HD		50 (37)	3 (80)

TABLE B
GEAR PUMP AND ELECTRIC MOTOR DRIVER
SELECTION

System Components

The TYCO AQUAMIST Mist Control Center (MCC) Pump Skid Unit is available in numerous configurations suitable for various applications, including Wet Pipe, Single and Multiple Zone Deluge and Preaction.

The MCC has been designed to readily incorporate 1-1/2–3 inch (DN40–DN80) valve risers. The valve riser and all associated trim are located inside of the Red-E Cabinet.

1. For on-board valve and trim configurations, which are typical for single zone systems, all components are provided pre-assembled, pre-plumbed, and pre-wired. In this case, the riser and Red-E Cabinet are mounted directly to the pump assembly.
2. For off-board valve and trim configurations, which are typical for multiple zones, or when it is desirable to install the fire protection control valve and the pump in different locations, the pump unit with controller and associated devices is provided as a pre-assembled unit, and each fire protection control valve, trim, and related devices are provided in one or more stand-alone Red-E Cabinets.

Typical Components

MCC Pump Skid Units include components typical to all system configurations (Ref. Figure 1). For information about TYCO components refer to data sheets noted. Otherwise refer to manufacturer's data sheets.

Gear Pump and Electric Motor Driver

Refer to Table B

Fire Pump Controller

Tornatech Model GPA or GPA+GPU

Control Panel (Optional)

Potter PFC-4410-RC

Pressure Relief Valve

TYCO RV-1 (Ref. TFP1585)

System (Manual)

Shut-Off Control Valve

TYCO BFV-N (Ref. TFP1510)

Thermal Relief Valve

Therm-Omega-Tech 154-010100-100

Specific System Components

MCC Pump Skid Units include components for specific system configurations (Ref. Figure 1). For information about TYCO components refer to data sheets noted. Otherwise refer to manufacturer's data sheets.

Wet Pipe System

Alarm Valve

TYCO AV-1 (Ref. TFP910)

Pressure Control Switch

Potter PCS-300-1B

Water Flow Switch

Potter PS-100

Standby Pressure Pump

Albany CEP93 (50 Hz and 60 Hz motor)

Deluge System

Deluge Valve

TYCO DV-5 (Ref. TFP1305)

Water Flow Switch

Potter PS10-2A

Electric Actuation Trim

TYCO DV-5 (Ref. TFP1320)

Preaction System

Deluge Valve

TYCO DV-5 (Ref. TFP1305)

Riser Check Valve

TYCO CV-1FR (Ref. TFP950)

Single Interlock Preaction System

TYCO DV-5 (Ref. TFP1420)

Double Interlock Preaction System

TYCO DV-5 (Ref. TFP1465)

Design Considerations

The system designer must consider and make preparations for use of the TYCO AQUAMIST Mist Control Center (MCC) Pump Skid Unit as follows:

1. Unit dimensions (Ref. Figure 2)
2. Adequate floor space for installation and maintenance of the unit
3. Adequate clearance for opening of pump controller, valve cabinet, and alarm panel doors
4. Adequate clearance to maneuver the MCC Pump Skid Unit through hallways and doors as necessary to place the system in its installation location.
5. Minimum ambient temperature of 40°F (4°C)
6. Installation of a suitably sized water supply to the supply header. (0 psi, sufficient flow capacity to match system design calculation.)
7. Installation of system piping from valve cabinet outlet(s)
8. Installation of system piping between pump unit and valve cabinet(s), if necessary
9. Installation of drains from main drain header and drip funnel headers
10. Installation of pump test header
11. Power supply to pump controller
12. Power supply to releasing panel
13. Power supply to excess pressure pump (Wet Valve models only)
14. Installation of detection system components (when required)
15. Power supply to air compressor (Preaction models only)

Nominal Dimensions Inches (mm)			
	MCC-1 & MCC-A	MCC-2 & MCC-B	MCC-3 & MCC-C
A	40 (1016,0)	52 (1320,8)	52 (1320,8)
B	10 (254,0)	15 (381,0)	15 (381,0)
C	28 (711,2)	31 (787,4)	34 (863,6)
D	14 (355,6)	17 (431,8)	17 (431,8)
E	10.25 (260,4)	10.75 (273,1)	13 (330,2)

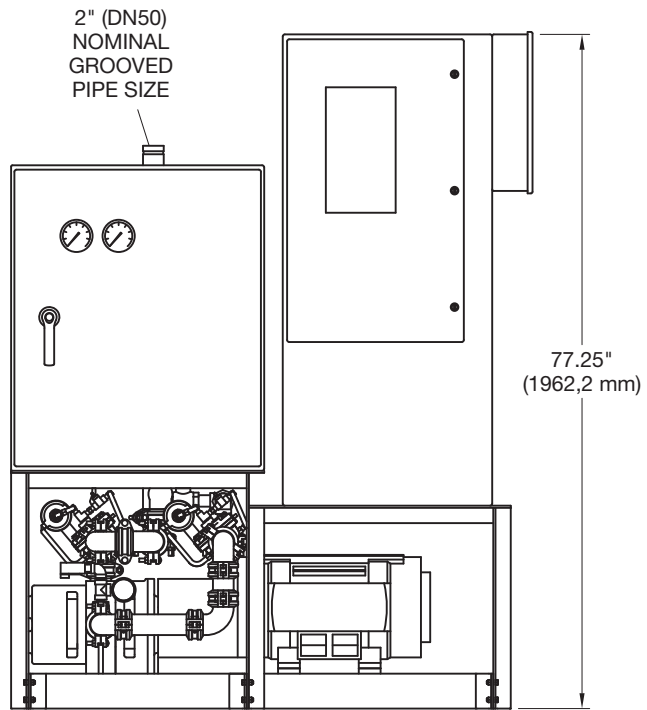
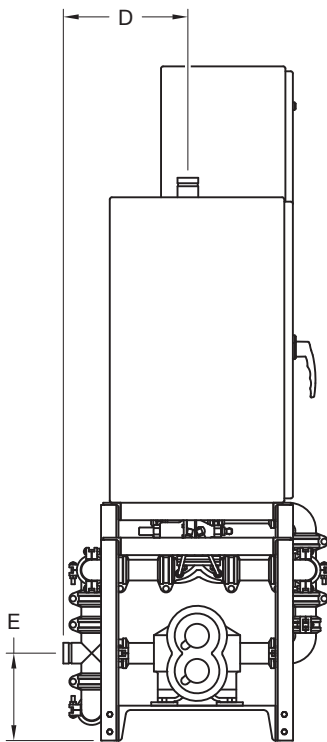
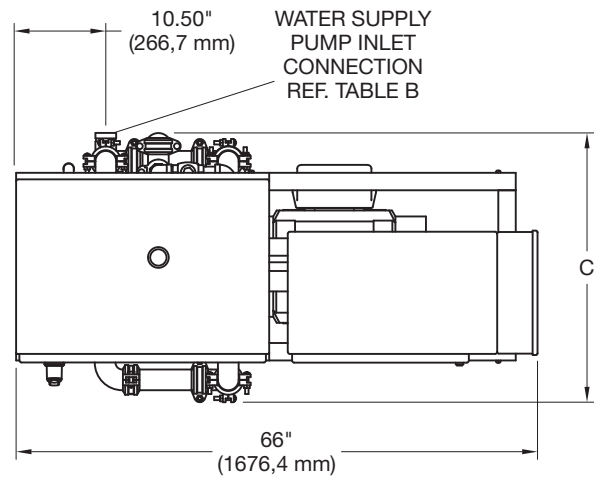
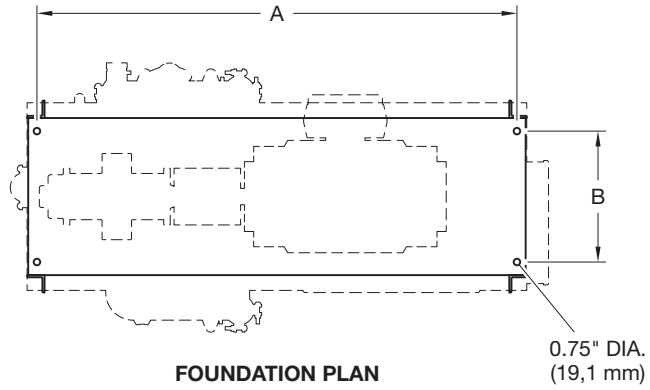

FIGURE 2
AQUAMIST MIST CONTROL CENTER PUMP SKID UNIT
INSTALLATION DIMENSIONS

Installation

The TYCO AQUAMIST Mist Control Center (MCC) Pump Skid Unit must be installed in accordance with this section.

Placing and Positioning

The MCC should be located with adequate space to ensure access to all serviceable components. Adequate floor space to facilitate opening of the pump controller, valve cabinet, and alarm panel doors should be maintained.

The pump unit must be securely mounted or otherwise fastened on a smooth, level, hard surface capable of supporting the full weight of the unit in such a way that pump and motor shaft alignment will be maintained. The pump and motor must be mounted on a common grouted baseplate. The mounting foundation absorbs vibrations, strains, or shock, while providing a permanent, rigid support for the pump skid.

System Piping Connection

Piping connections to the MCC must be made in accordance with NFPA 20 and NFPA 750, or other installation code acceptable to the authority having jurisdiction.

The MCC requires four piping connections: water supply; system connection; main drain; and funnel drain(s).

The inlet piping should be equal to, or one size larger than, the pump inlet connection (Ref. Table B). The pump should not be operated under static lift conditions without consulting the pump manufacturer (Ref. Item 6, Design Considerations). Do not install 45-degree or 90-degree fittings at the pump suction port. When possible, provide at least 20 pipe diameters of straight pipe at the suction port.

A pump inlet strainer, as required by NFPA 20, must be equipped with a removable and cleanable suction strainer, and installed at least 10 pipe diameters from the pump suction inlet. (For strainer mesh size selection, refer to specific data sheets of pumps listed in Table A for manufacturer's recommendations.) The net open area of the strainer must be at least 4 times the area of the suction piping.

The suction strainer should be located in the horizontal position with the clean-

out plug toward the floor. The strainer may, however, be oriented in the vertical position provided that the clean-out plug is facing toward the floor. The pump should not be operated without the strainer in place as foreign material may be large enough to damage the pump. To avoid pump cavitation, the Net Positive Suction Head (NPSH) supplied should exceed the pump manufacturer's required NPSH plus 5 feet of liquid. (Refer to Technical Data Sheets of pumps listed in Table B.)

Downstream (on the system side) of the AQUAMIST MCC Pump Skid Unit, a filter or strainer is required at the supply side of each nozzle and at the point of transition to corrosion resistant pipe per NFPA 750. Strainers are ordered separately from the AQUAMIST MCC Pump Skid Unit. For selection and ordering of inlet and discharge strainers tested and approved for use with the AQUAMIST MCC Pump Skid Unit, refer to the Ordering Procedure section and Table D.

A supervised shutoff valve (not included) should be between the water source and the pump inlet to facilitate servicing of the pump unit.

Electrical Requirements

The standard MCC is delivered pre-configured for 460 volt, 60 Hz 3 phase power. Other voltages and frequencies are available as special order items. Electrical power supplies should be in accordance with National Electric Code (NFPA 70), NFPA 20, and/or equivalent local electrical codes.

Power supply conductors must be sized according to the National Electric Code (NFPA 70), or equivalent local electrical code, on a continuous duty basis. The incoming conductors should have a 140°F (60°C) or 167°F (75°C) current rating of not less than 125% of the motor full load current carrying capacity.

Conduit entrance can be made only through the bottom gland plate of the controller. Use appropriate waterproof conduit hubs to keep water out of the controller.

The pump unit can be special ordered with a wide range of electrical configurations, including alternate voltages and frequencies. For additional details, please contact the Technical Services department.

For additional installation instructions, please see the installation, operation, and maintenance manual, *AQUAMIST Mist Control Center (MCC) Pump Skid Unit Installer's Manual*, (Doc MCCA001), provided with the AQUAMIST MCC Pump Skid Unit. In addition to the preceding requirements, it provides information for the following installation steps:

1. Placing and positioning of the MCC unit
2. Connecting the system piping
3. Connecting the electrical circuits
4. Programming the control panel
5. Setting the automatic control valve
6. Setting the pump supply pressure
7. Testing and commissioning the system

Care and Maintenance

The TYCO AQUAMIST Mist Control Center (MCC) Pump Skid Unit must be maintained and serviced in accordance with this section.

Before closing a fire protection system main control valve for maintenance work on the fire protection system that it controls, permission to shut down the affected fire protection systems must first be obtained from the proper authorities and all personnel who may be affected by this decision must be notified.

Inspection, testing, and maintenance must be performed in accordance with the requirements of NFPA 25 and any impairment must be immediately corrected.

The owner is responsible for the inspection, testing, and maintenance of their fire protection system and devices in compliance with this document, as well as with the applicable standards of any authorities having jurisdiction. The riser components enclosed within the MCC, however, must be maintained in accordance with their applicable technical data sheets referenced in the System Components section. Contact the installing contractor or product manufacturer with any questions.

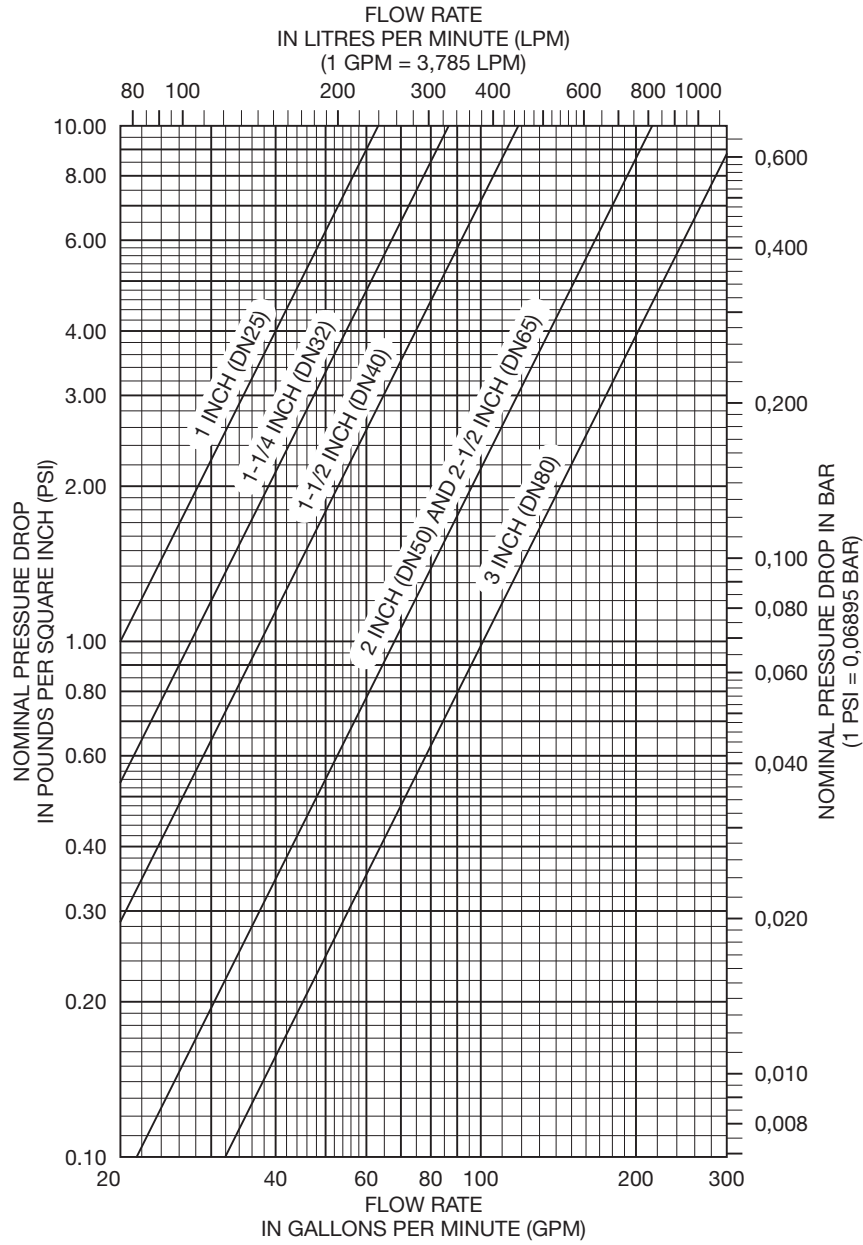

GRAPH A
BRONZE SYSTEM STRAINERS
NOMINAL PRESSURE LOSS VS. FLOW

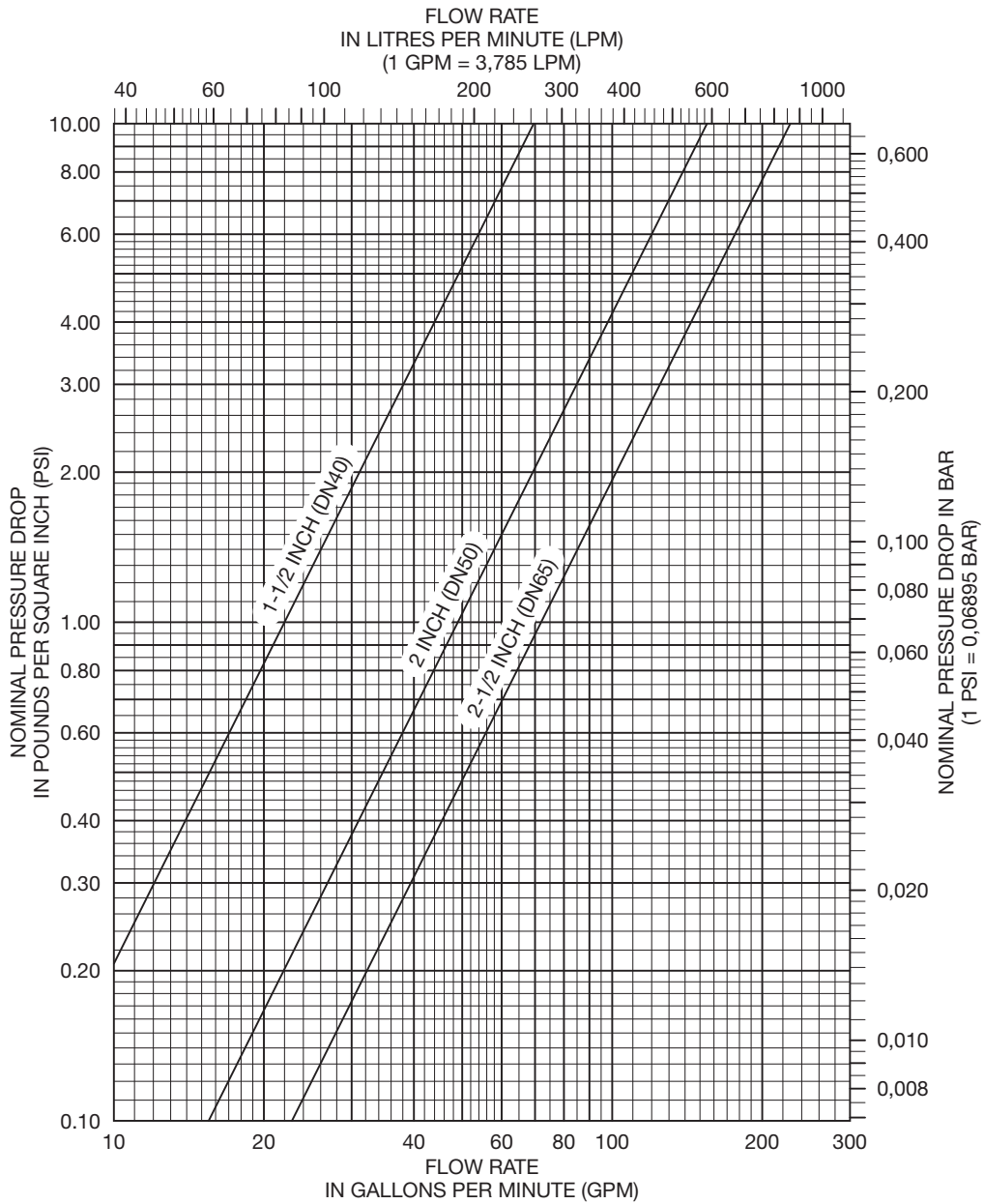

GRAPH B
STAINLESS STEEL SYSTEM STRAINERS
NOMINAL PRESSURE LOSS VS. FLOW

P/N MCC-XXXXXX

Model		Backup Power		Electrical		Actuation		Valve & Trim Location		Release Panel		
				Frequency	Voltage							
1	MCC-1	0	No Transfer Switch			1	Deluge Electric	1	On-board	0	No Panel	
2	MCC-2	1	With Transfer Switch	1	50	380	2	Wet Pipe	2	Off-board	1	PFC-4410 RC
3	MCC-3			2	50	415	3	Double Interlock Preaction Electric-Electric*				
A	MCC-A			3	60	208	4	Single Interlock Preaction				
B	MCC-B			4	60	230	5	Double Interlock Preaction Electric-Pneumatic*				
C	MCC-C			5	60	460						
				6	60	575						

* Non-FM Approved Configuration

TABLE C
AQUAMIST MIST CONTROL CENTER PUMP SKID UNIT
PART NUMBER SELECTION

Model	Size Inches (mm)	Connection	Material	TYCO P/N
Watts Mueller 781-SS	0.75 (19)	Flange	316SS	3/4" 781-SS
Watts Mueller 781-SS	2 (51)	Flange	316SS	2" 781-SS
Watts Mueller 781-SS	2.5 (64)	Flange	316SS	2-1/2" 781-SS
SSI-250Y1	1 (25)	NPT	Bronze	0100-250Y1TB-A2
SSI-250Y1	1.25 (32)	NPT	Bronze	0125-250Y1TB-A2
SSI-250Y1	1.5 (38)	NPT	Bronze	0150-250Y1TB-A2
SSI-250Y1	2 (51)	NPT	Bronze	0200-250Y1TB-A2
SSI-250Y1	2.5 (64)	NPT	Bronze	0250-250Y1TB-A2
SSI-250Y1	3 (76)	NPT	Bronze	0300-250Y1TB-A2

TABLE D
INLET AND DISCHARGE STRAINER
PART NUMBER SELECTION

Limited Warranty

For warranty terms and conditions, visit www.tyco-fire.com.

Ordering Procedure

Contact your local distributor for availability. When placing an order, indicate the full product name and part number (P/N).

AQUAMIST Mist Control Center (MCC) Pump Skid Unit

Specify: AQUAMIST Mist Control Center (MCC) Pump Skid Unit, P/N (specify from Table C)

Note: All double-interlock preaction actuation configurations are not FM Approved.

Inlet and Discharge Strainer

Specify: Strainer, P/N (specify from Table D)